

ALUMINIUM PROPS

Asso  srl
www.assosrl.net

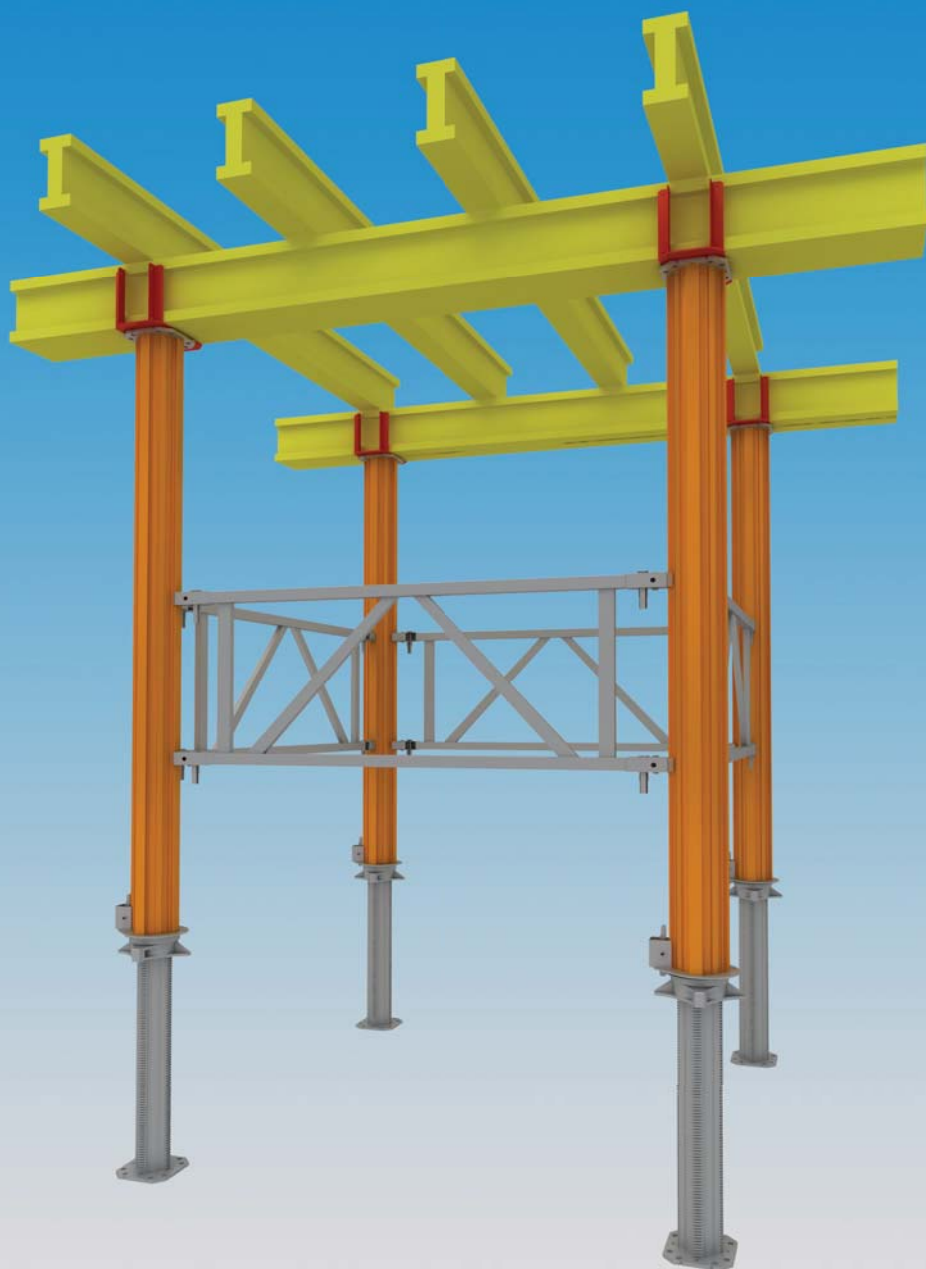

— LIGHTNESS

— HIGH LOADS

— FAST ASSEMBLY FOR SHORING TOWERS

— MADE IN ITALY

EN-16031 ASSOPROP 105 ALUMINIUM

NOT PAINTED	ENGINEERING DATA	PAINTED
PUNT2500105	- h closed 1.45 m - h open 2.5 m - weight 14 kg	PUNT2500105V
PUNT3500105	- h closed 1.95 m - h open 3.5 m - weight 19,5 kg	PUNT3500105V
PUNT4800105	- h closed 3.3 m - h open 4.8 m - weight 25 kg	PUNT4800105V
PUNT6250105	- h closed 4.8 m - h open 6.25 m - weight 31 kg	PUNT6250105V
Measure on request	Packing 49 pcs	Colour on request



EN-16031 ASSOPROP 70 ALUMINIUM

NOT PAINTED	ENGINEERING DATA	PAINTED
PUNT305070	- h closed 1.75 m - h open 3.05 m - weight 11 kg - class D/E30	PUNT305070V
PUNT420070D <i>DOUBLE ADJUSTEMENT</i>	- h closed 2.9 m - h open 4.2 m - weight 16,5 kg - class D40	PUNT420070DV <i>DOUBLE ADJUSTEMENT</i>

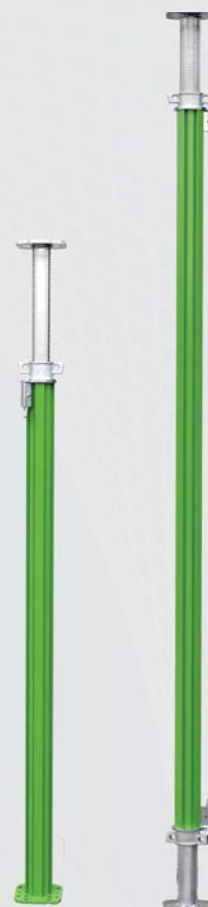

PUNT2500105

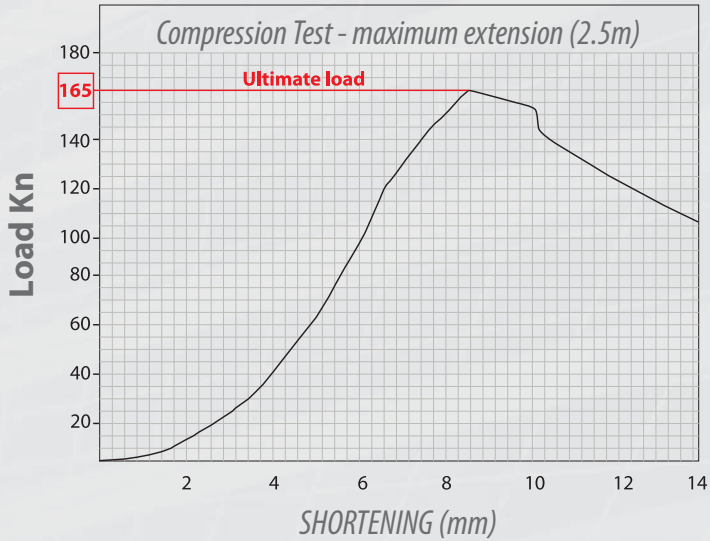

PUNT3500105

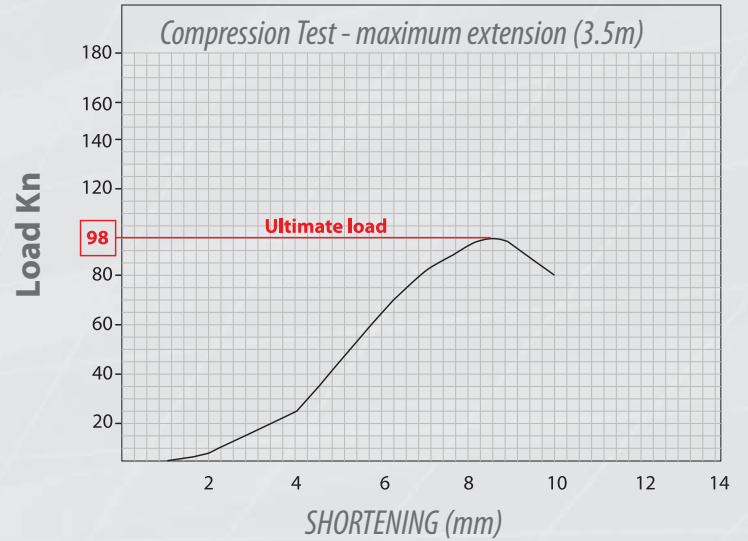

PUNT4800105

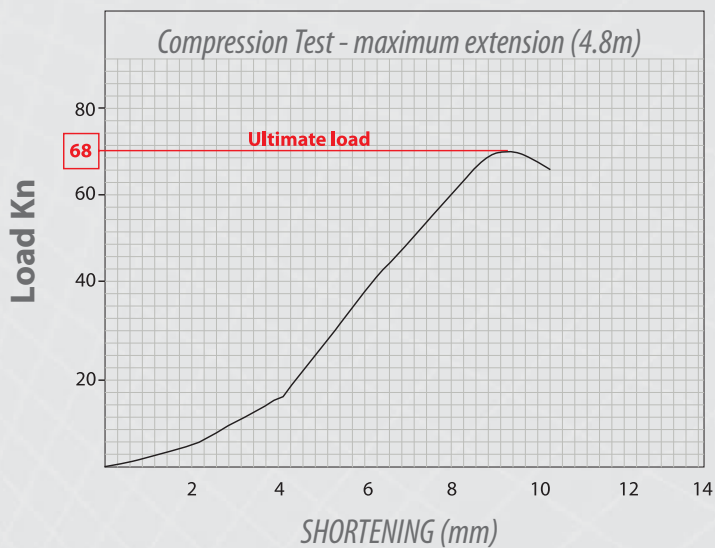

PUNT6250105

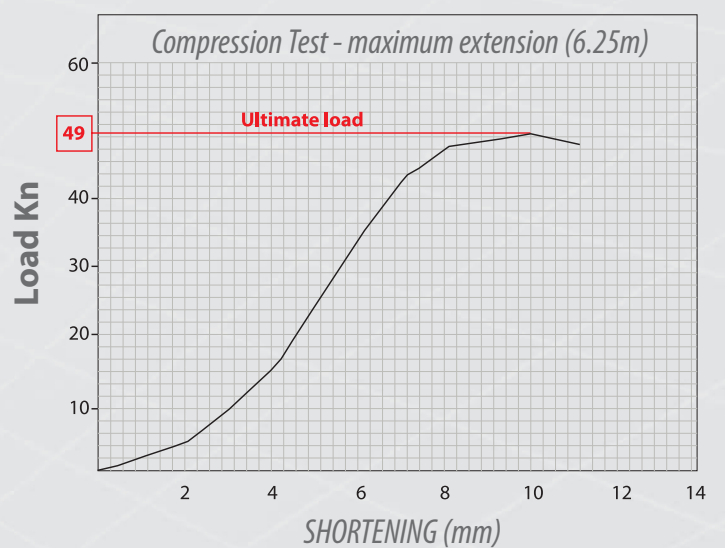

EXTENSION PROP 105/70 ALUMINIUM

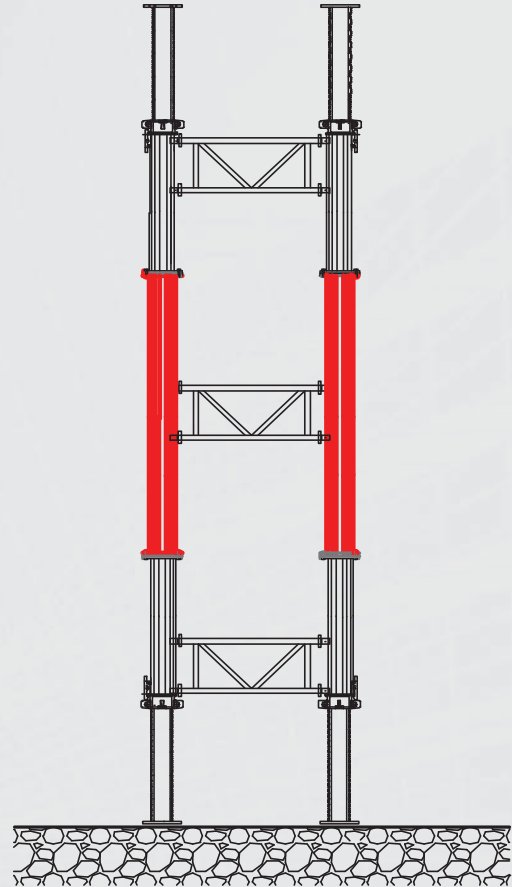
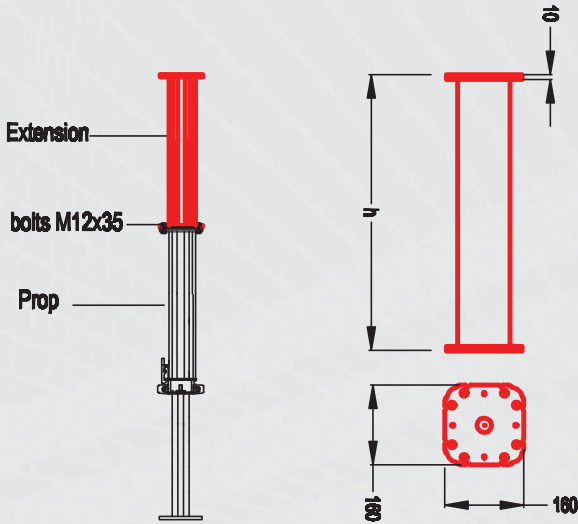

NOT PAINTED	ENGINEERING DATA	PAINTED
P500105	- h 0.5 m - weight 3.5 kg	P500105V
P1000105	- h 1 m - weight 5.6 kg	P1000105V
P1500105	- h 1,5 m - weight 5.6 kg	P1500105V
P2000105	- h 2 m - weight 10 kg	P2000105V
P3000105	- h 3 m - weight 14.4 kg	P3000105V



STEEL FRAMES

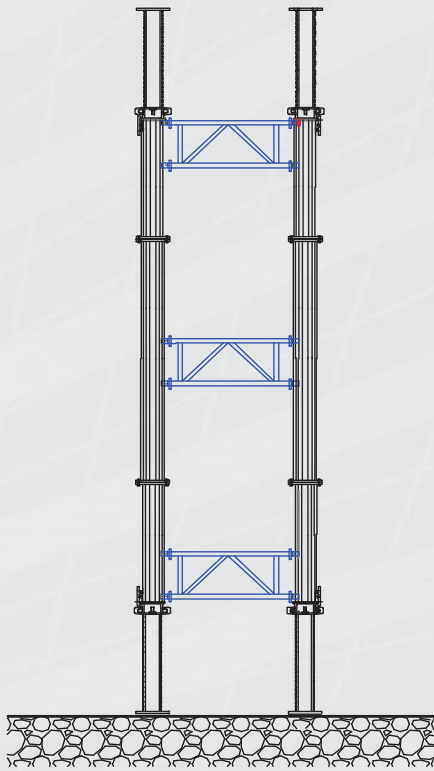

L (center prop)

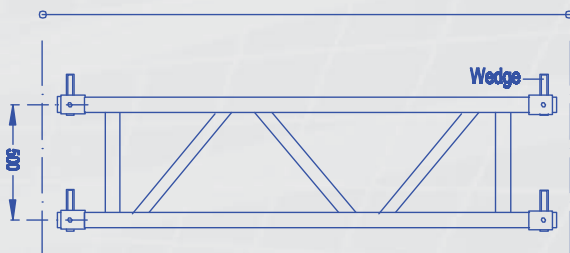

TL750105SZC	<ul style="list-style-type: none"> - L = 0.75 m - kg 7 - zincated - packing 40 pcs
TL1000105SZC	<ul style="list-style-type: none"> - L = 1 m - kg 9 - zincated - packing 40 pcs
TL1500105SZC	<ul style="list-style-type: none"> - L = 1,5 m - kg 12 - zincated - packing 20 pcs
TL2000105SZC	<ul style="list-style-type: none"> - L = 2 m - kg 14,5 - zincated - packing 20 pcs

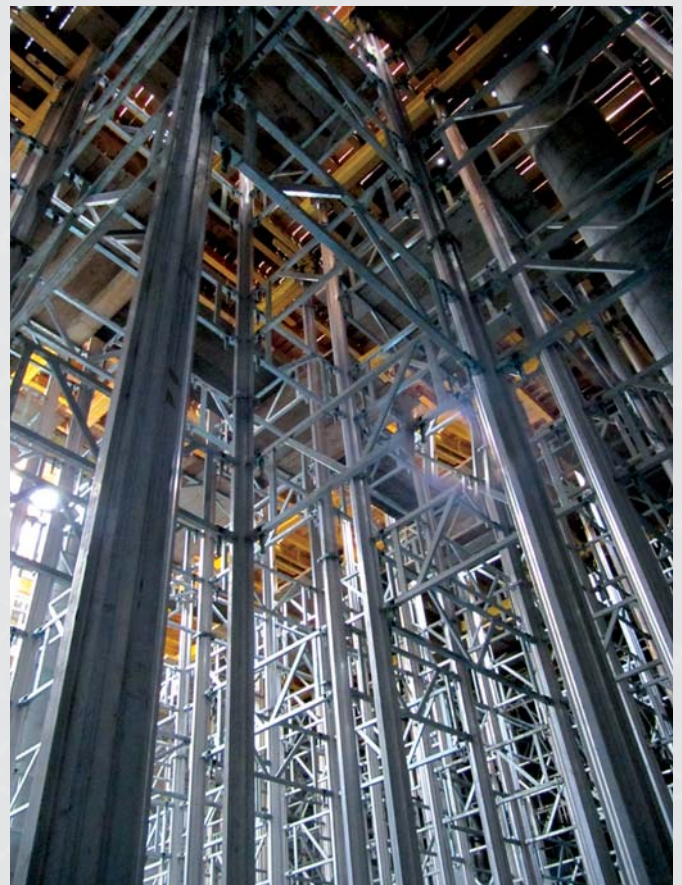

ACCESSORIES

WOODEN BEAMS		
ARTICLE	LENGHT	WEIGHT KG
TRV190	1.9 m	9.5
TRV245	2.45 m	12.2
TRV290	2.9 m	14.5
TRV330	3.3 m	16.5
TRV360	3.6 m	18
TRV390	3.9 m	19.5
TRV490	4.9 m	24.5
TRV590	5.9 m	29.5

TRIPOD

- Article: TRP1160
- Weight: 10.6 kg
- Red painted



RELEASE FOOT

- Article: PD105
- Weight: 6 kg
- Painted



BEAM FORK

- Article: FC80x160
- Weight: 2,5 kg
- Red painted



ADJUSTABLE SPANNER

- Article: CHIAVE105MZ
- Weight: 1.5 kg
- Zincated



CONNEXION BOLT

- Article: VTDE1235
- Weight: 0.065 kg
- Zincated



BASKET PROPS

- Article: CNTPUNT1040
- Measure: 1260x1160xh1220
- Weight: 58 kg
- Packing: 49 pcs
- capacity load: Kn 12



BIG BASKET PROPS

- Article: CNTPUNT2700
- Measure: 2770x1160xh1180
- Weight: 110 kg
- packing: 49 pcs
- capacity load: Kn 15



BASKET FRAMES

- Article: CNTTELAIO
- Measure: 1200x800xH1150
- Weight: 38 kg
- packing: 20/40 pcs
- lifting: by crane or fork lift



STANDARD BASKET

- Article: CASSONEASSO
- Measure: 1200x800xH800
- Weight: 110 kg
- blu painted
- lifting: by crane or fork lift

